

Evaluation Kit

APPLICABLE PARTS (SOLD SEPARATELY)

- PA50
- PA52

INTRODUCTION

This easy to use kit provides a platform with good circuit board layout and grounding to evaluate linear power amplifier circuits using the PA50 / PA52 pin out. With additional prototype area, it is flexible enough to analyze a multitude of standard or proprietary circuit configurations. All components are provided with the kit. External connections to the evaluation kit can be made through the connectors at the edges of the circuit. The circuit provides a line termination of 50 Ω.

The Power amplifiers are configured for a gain of 21. This evaluation kit provides flexibility for modifying the gain, in inverting or non-inverting mode and for using a differential amplifier configuration.

Figure 1: PCB

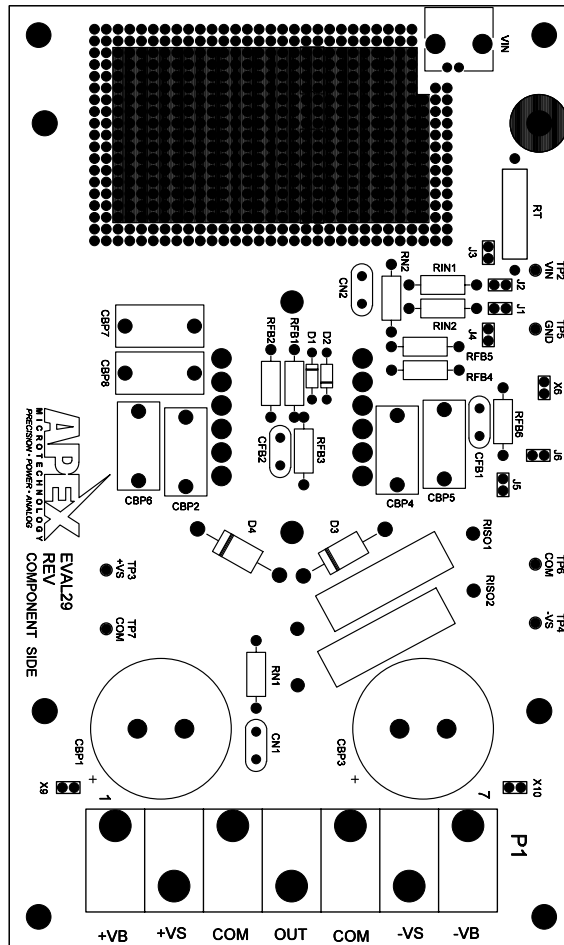

Figure 2: Schematic for Non-Inverting Amplifier

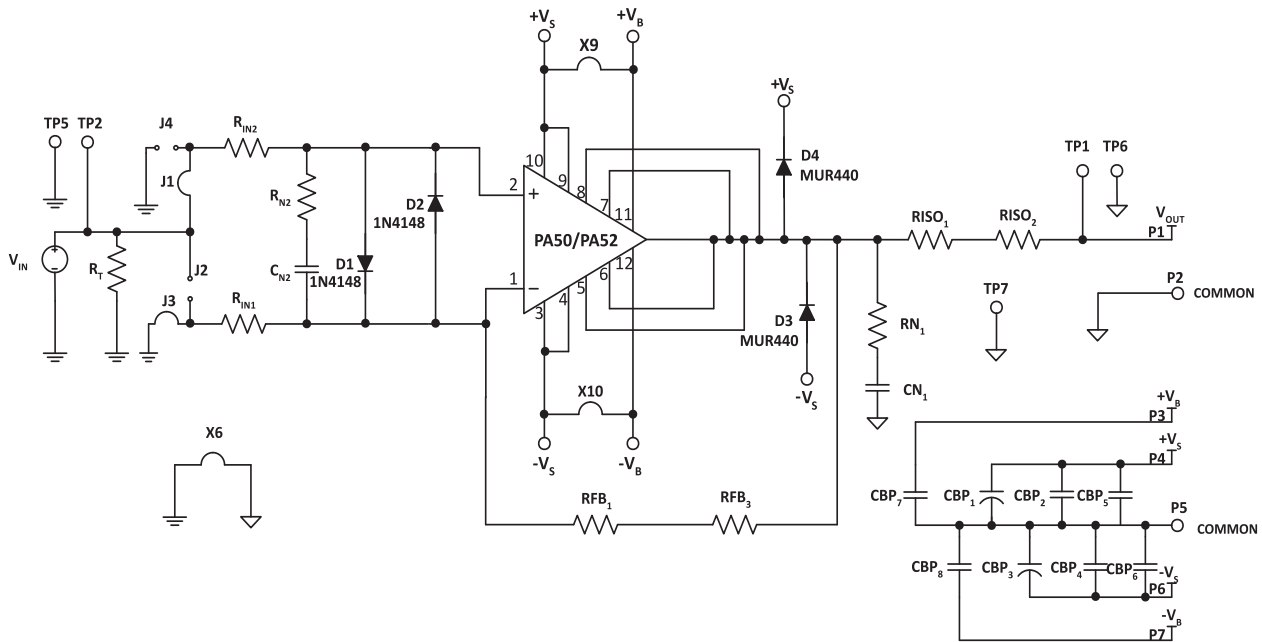
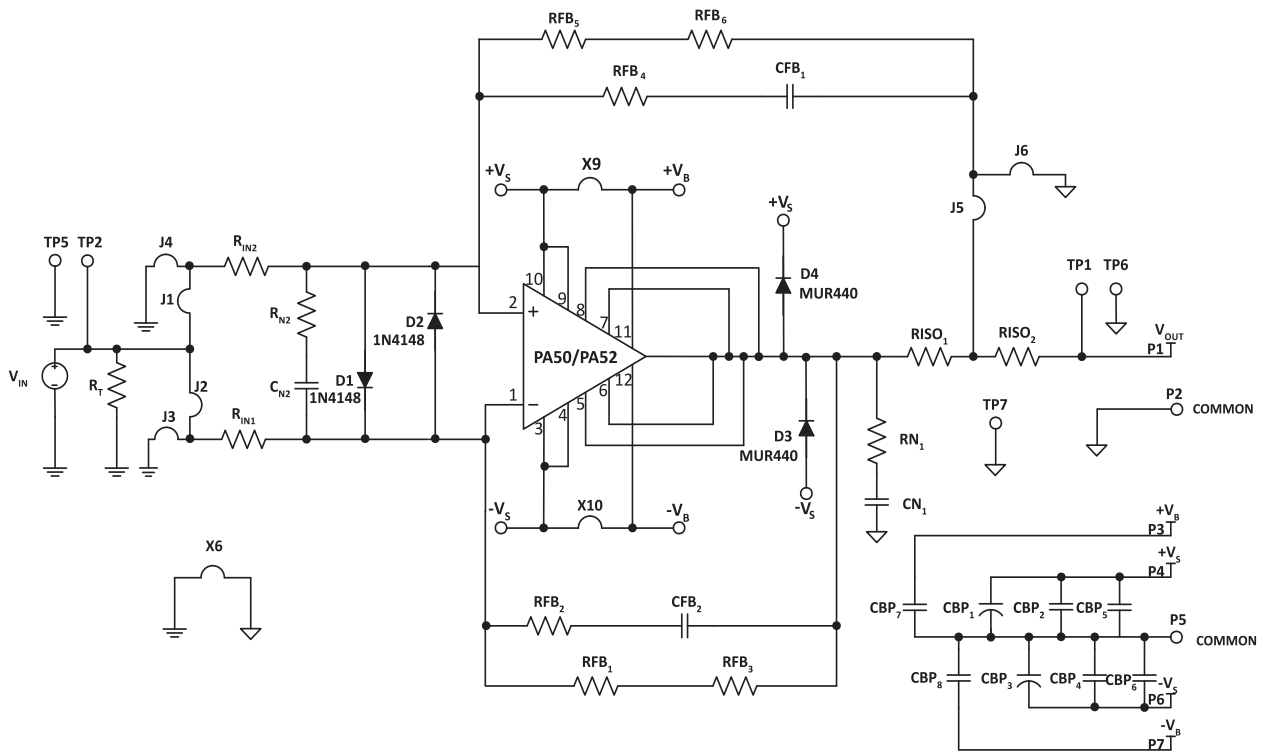

Figure 3: Assembled Schematic



PARTS LIST

Reference	Manufacturer Part #	Description	QTY
<u>Resistors</u>			
RT	PR03000205109JAC00	51 Ω , 3W, 5%	1
RIN-1, RIN-2	RN60D1801FB14	1.8 K Ω , 1/4W, 1%	2
RFB1-B, RFB3-B	RN60D1802FB14	18 K Ω , 1/4W, 1%	2
RIS0-1, RIS0-2	Not Included	0 Ω , Wire Jumper	2
<u>Printed Circuit Board</u>			
EVAL29	EVAL29	Printed Circuit Board	1
<u>Capacitors</u>			
CBP-1, CBP-3	SLP222M100C4P3	ALUM, 2200Uf, 100V	2
CBP-1', CBP-3'	SLP681M200C7P3	ALUM, 680uF, 200V	2
CBP-2, CBP-4			
CBP-5, CBP-6	ECW-F21055A	FILM, 1uF, 250VDC	6
CBP-7, CBP-8			
<u>Diodes</u>			
D1, D2	1N4148-T	Switching Diode	2
D3, D4	MUR440 G	Rectifier, Ultra Fast	2
<u>Hardware</u>			
	HS18	Heatsink	1
	TW05	Thermal Washer (Pack Of 10 Pcs)	1
	MS05	Socket	1
	146510CJ	BNC Connector, PC Mount	1
	91735A190	Screw, Panhead, #8 X 0.25"	4
	91735A192	Screw, Panhead, #8 X 0.375"	4
	91841A009	Nut, Hex, #8	4
	8426	Spacer, Hex, With Stud, #8 X 0.375"	4
	8413	Spacer, Hex, With Stud, #6 X 0.375"	4
	2221	Standoff, Hex, #8 X 2.00"	4
	91735A151	Screw, Panhead, #6 X 0.75"	2
	90730A007	Nut, Hex, #6 X 1/4"	2
	TSO2	Terminal Strip	1
<u>Miscellaneous</u>			
	TFT20014 NA005-6"	Tubing, Teflon, #18AWG, 6 Inches	1
	SPC02SVJN-RC	Jumper, Slip On	10
	PRPC002SADN-RC	Header, Connector	10
	5001	Test Point, Pc Mini	10

BEFORE YOU GET STARTED

- All Apex Microtechnology amplifiers should be handled using proper ESD precautions.
- Always use the heat sink and thermal washers included in this kit.
- Always use adequate power supply bypassing.
- Do not change the connections while the circuit is powered.
- Initially set all power supplies to the minimum operations levels allowed in the device data sheet.
- Check for oscillations.
- Please refer to Application Note, AN01 for general operating conditions.

ASSEMBLY

During the assembly, please refer to the circuit schematics, assembly drawings, and the data sheet of the part being used on the evaluation kit.

1. Note that each side of the circuit board is identified as either the component side or the DUT side. The component side has the designators printed on that side.
2. All the components are installed on the component side of the board and soldered on the DUT side.
3. First mount diodes D1, D2 and resistors RFB1, RFB3 on the component side of the board.
4. A power DIP socket (MS05) is supplied with this kit. The MS05 socket incorporates two cavities to retain the #6 x 1/4" nuts (90730A007). Insert one #6 nut into each cavity. Make sure the nuts are fully seated into the cavities. Using #6 x 0.75" screws (91735A151) provided with the kit, mount the socket from the DUT side of the board.
5. Attach the heat sink to the board from the DUT side, using #8 x 0.375" screws (91735A192). Refer to the assembly drawings for the correct way to attach the heat sink. This is done to keep the socket tightly mounted to the board and to provide support, and eliminate stress so that the socket pins do not move while being soldered from the component side. Once the socket pins are soldered, and the socket is now attached to the board, remove the heat sink and all the screws.
6. First install all the smaller components on the board. This is done because it becomes difficult to install a smaller part on the board once all the larger components are installed.
7. In most applications, RISO-1 and RISO-2 will be shorted; use 2 pieces of 16 AWG wire (1.5mm) (not included) to short RISO-1 and RISO-2.
8. Mount electrolytic capacitors CBP-1 and CBP-2 for PA50. Mount capacitors CBP-1' and CBP-2' for PA52.
9. Ensure that the orientation of the electrolytic capacitors and the diodes match the circuit schematic drawing.
10. Mount the BNC connector provided with the kit (146510CJ) and solder it to the board. Also mount the terminal strip (TSO2) provided in the kit. Refer to the assembly drawings before mounting the terminal strip. Make sure the terminal strip sits flat against the circuit board.
11. #8 hex stand offs (91841A009) are also provided with the kit. Install the # 8 x 0.25" screws (91735A190), provided with the kit, from the component side. Attach the standoffs to these screws on the corners of the board. Refer to the assembly drawings while installing the standoffs.
12. Attach the heatsink as before in step 5. Cut the Teflon tubing into 12 pieces, each of length 0.21 inches or 5.33mm (1/5 of an inch) approximately. These pieces go onto the pins of the Power Amplifier before inserting it into the socket. This is done to insulate the pins from the heat sink and make sure that the PA is tightly fixed into the socket. An Exacto knife works well for this.
NOTE: The Teflon pieces should not be longer than the suggested length. If the pieces are longer, they may interfere in the seating of the part to the heat sink and create a gap between the heat sink and the part body.
13. Ten thermal washers (TW05) are provided with the kit. The thermal washer is used between the part and the heat sink. A new washer must be used for each mounting. Mount the Power amplifier to the socket using the thermal washer provided with the kit. Secure with the #6 screws. Note, the pin closest to the input resistors (RIN1 and RIN2) is the pin #1 of the amplifier.
14. Place jumpers J1 and J3 for a non-inverting amplifier. Connect X6 jumper.
15. Connect jumpers X9 and X10 to connect boost voltage and supply voltage.
16. Connect the external connections via the BNC connector and terminal strip. Hook up power supply and signals as necessary. The amplifier is now ready for testing.

Figure 3 shows the schematic diagram for the assembled circuit.

Figure 4: Top View

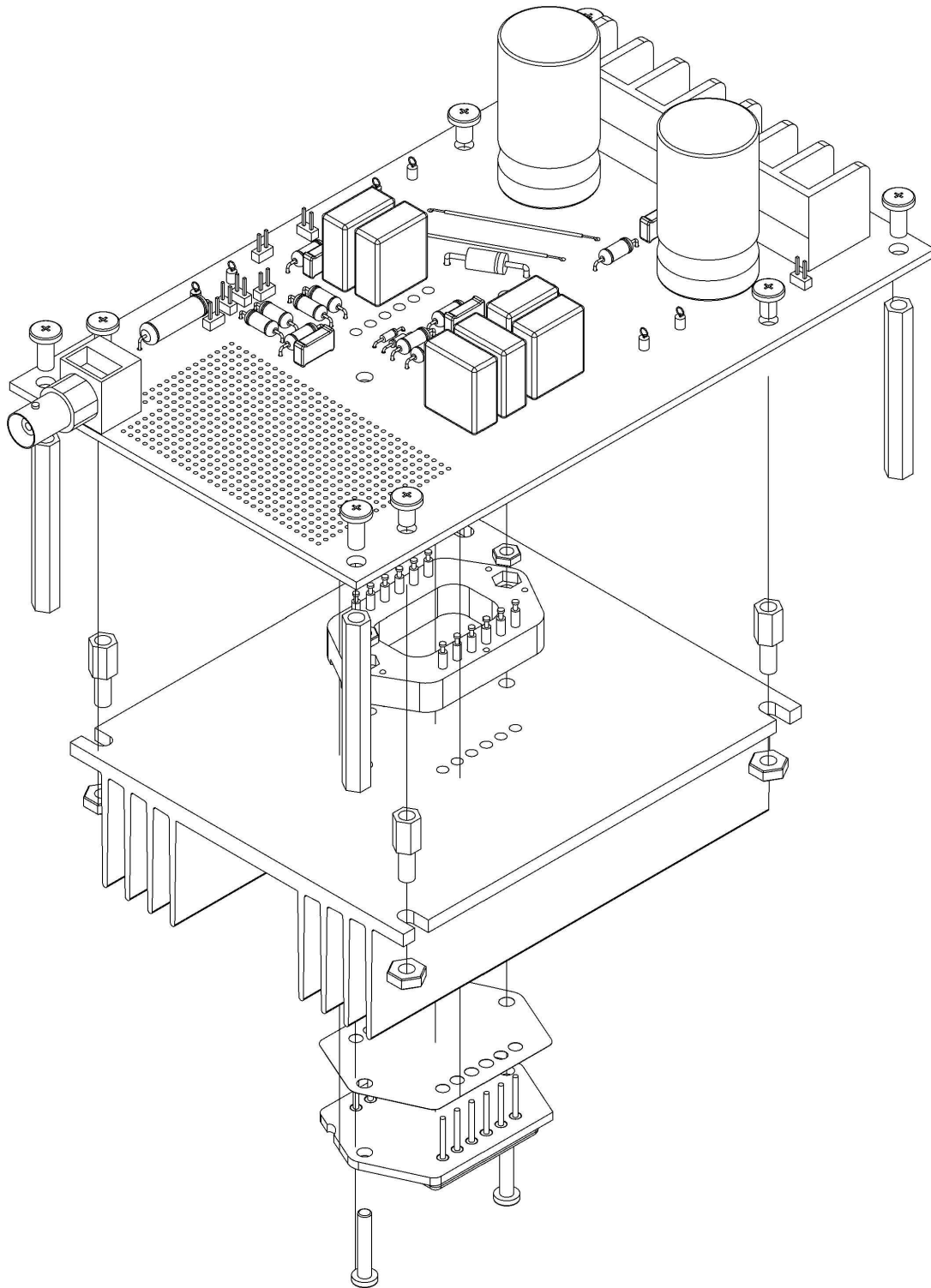
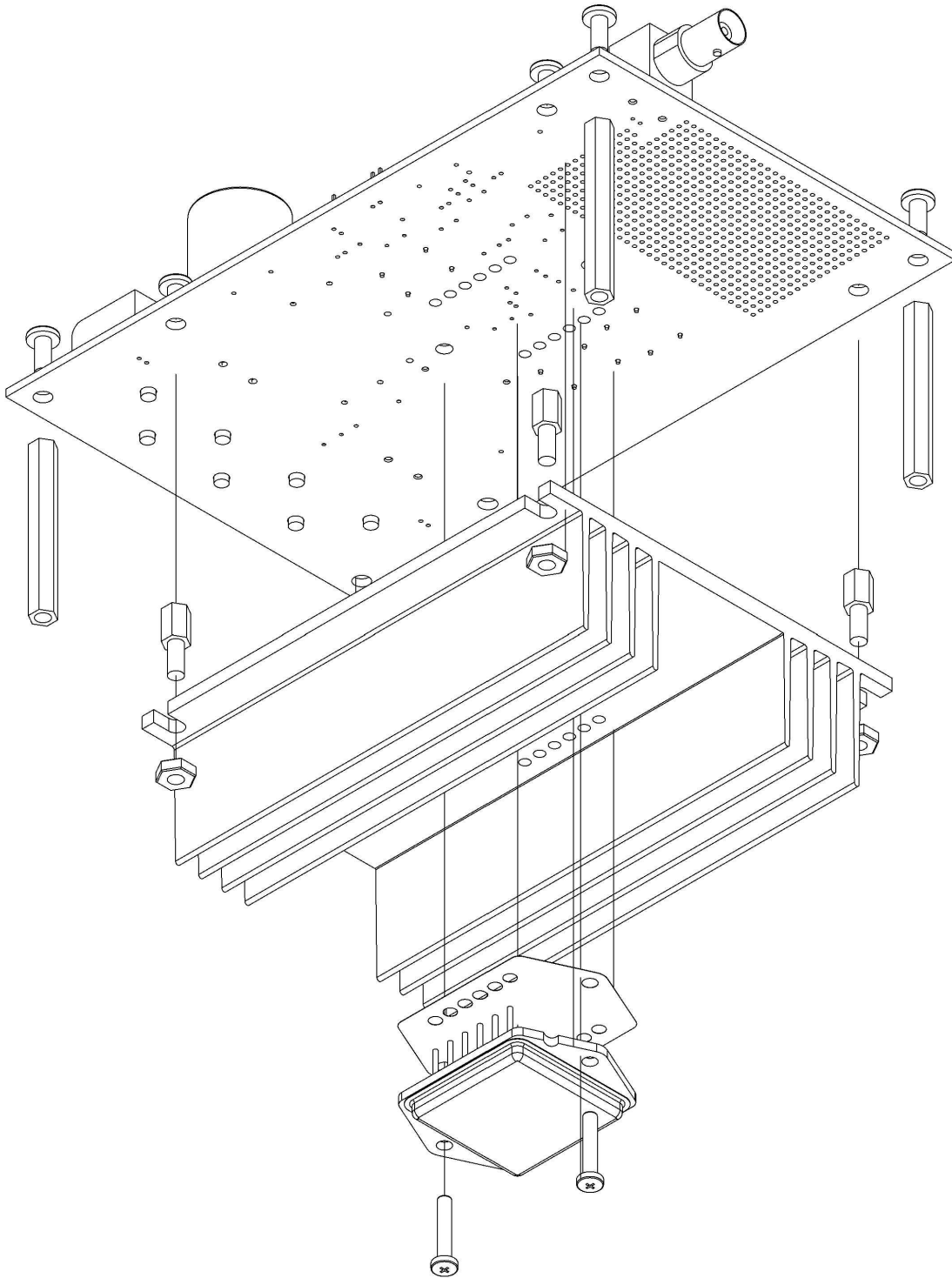

Figure 5: Bottom View



TEST ASSEMBLY

Equipment needed:

1. Power supply
2. Function Generator
3. Oscilloscope
4. Proper heat sinking system (if operating at high current)

TEST SETUP

Connect the power supply to the terminal strip. Connect the BNC cable from the function generator to the BNC connector marked VIN, mounted on the board. Connect the load to the terminals on the terminal strip. Refer to the amplifier datasheet for typical values of input voltage, frequency and supply voltage. Input and output waveforms can be checked on an Oscilloscope by connecting it to the test points mounted on the board. Begin the test with minimum values of input and supply voltage

NOTE: After everything is connected, switch on the power to the board, and check the socket at each pin without the DUT, for correct voltage / signal at respective pin. Once this is done, plug in the DUT and check for the correct signal.

TEST RESULTS

Figure 6 shows input (yellow waveform) and output (blue waveform) waveforms for a PA52 power amplifier connected to a resistive load. The part was tested for an input voltage of $500\text{mV}_{\text{p-p}}$, at 10 kHz frequency. The supply voltage is set at ± 20 Volts.

Figure 6: Test Results

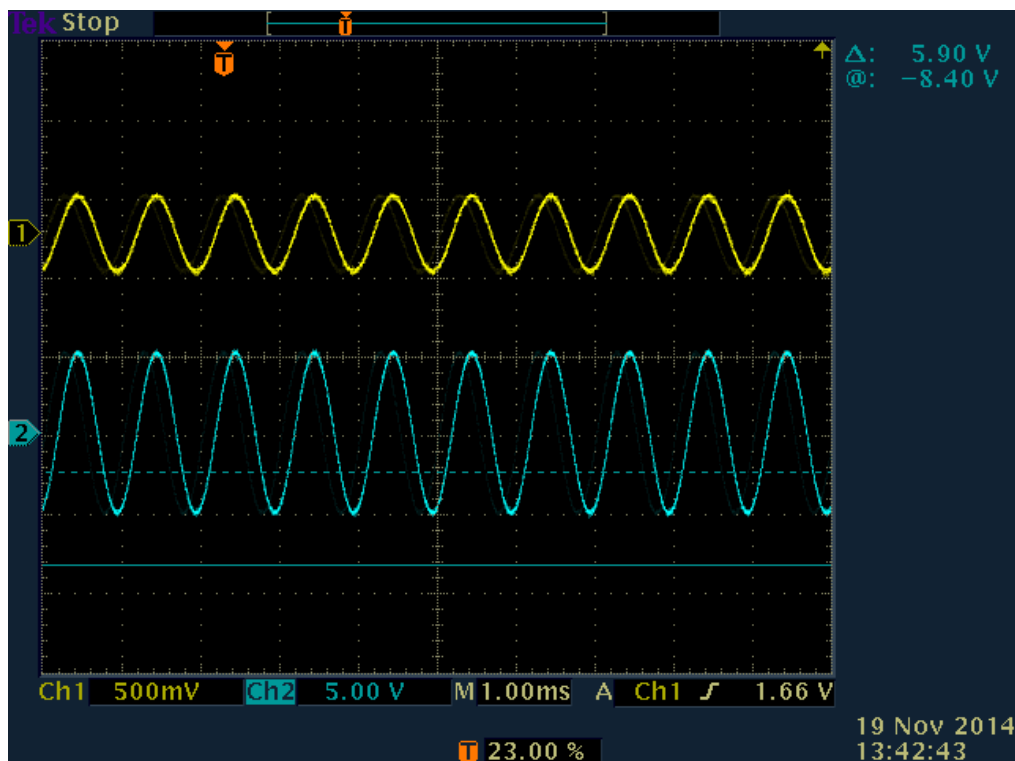

NEED TECHNICAL HELP? CONTACT APEX SUPPORT!

For all Apex Microtechnology product questions and inquiries, call toll free 800-546-2739 in North America. For inquiries via email, please contact apex.support@apexanalog.com. International customers can also request support by contacting their local Apex Microtechnology Sales Representative. To find the one nearest to you, go to www.apexanalog.com

IMPORTANT NOTICE

Apex Microtechnology, Inc. has made every effort to insure the accuracy of the content contained in this document. However, the information is subject to change without notice and is provided "AS IS" without warranty of any kind (expressed or implied). Apex Microtechnology reserves the right to make changes without further notice to any specifications or products mentioned herein to improve reliability. This document is the property of Apex Microtechnology and by furnishing this information, Apex Microtechnology grants no license, expressed or implied under any patents, mask work rights, copyrights, trademarks, trade secrets or other intellectual property rights. Apex Microtechnology owns the copyrights associated with the information contained herein and gives consent for copies to be made of the information only for use within your organization with respect to Apex Microtechnology integrated circuits or other products of Apex Microtechnology. This consent does not extend to other copying such as copying for general distribution, advertising or promotional purposes, or for creating any work for resale.

APEX MICROTECHNOLOGY PRODUCTS ARE NOT DESIGNED, AUTHORIZED OR WARRANTED TO BE SUITABLE FOR USE IN PRODUCTS USED FOR LIFE SUPPORT, AUTOMOTIVE SAFETY, SECURITY DEVICES, OR OTHER CRITICAL APPLICATIONS. PRODUCTS IN SUCH APPLICATIONS ARE UNDERSTOOD TO BE FULLY AT THE CUSTOMER OR THE CUSTOMER'S RISK.

Apex Microtechnology, Apex and Apex Precision Power are trademarks of Apex Microtechnology, Inc. All other corporate names noted herein may be trademarks of their respective holders.