

# MOTION CONTROL





## Motion Control

Position, Torque or Speed

- Brush
- Micro-steppers
- Linear (voice coil)
- Multi-phase AC
- Galvanometers



One of the largest applications for high power op amps is in motion control. High current high power op amps can be used for all components of motion control including speed control, position control and torque control. Their ease of use, rapid design ability and rugged hybrid construction lead to cost effective motion control systems.

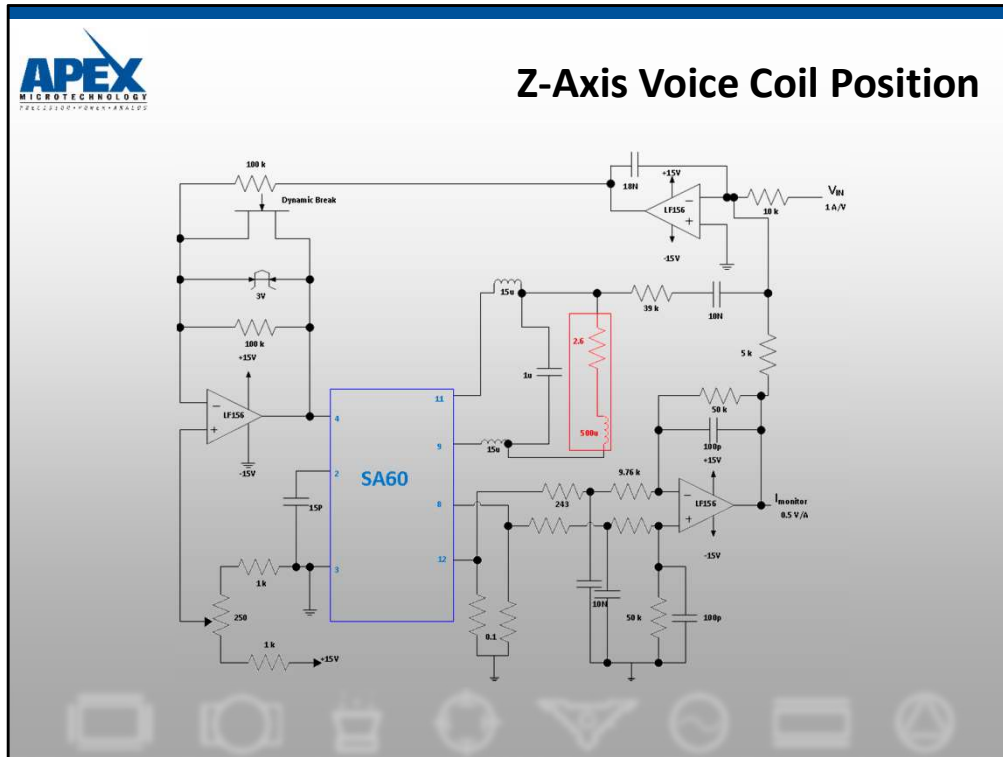

Slower versions of this machine used a PA12 linear op amp for Z-axis control. Even though currents were lower and motor impedance was higher, an exotic custom heat sink had to be designed to fit the small physical location of the amplifier. It was clear that this generation of the machine required higher efficiency in the drive circuit. The SA60 provides this and being programmed to switch at about 220KHz, it provides adequate bandwidth for the high speed servo loop.

Current sense resistors of 0.1Ω develop 1V at the 10A current peaks giving very good resolution and accuracy for the differential current monitor which provides the ½V/A feedback signal. Both poles of the differential amplifier were placed at roughly ¼ the switching frequency. This amplifier needs to be the fastest responding block of the system.

The pure integrator now reacts to any magnitude difference between feedback and input command signals. The 18nF makes the integrator significantly slower than the current monitor. The 39K/10nF network becomes the dominate feedback path just before the V-to-I phase shift of of the motor inductance brings on stability problems.

With the dynamic brake signal low, the last amplifier inverts the drive signal to the SA60 and limits drive amplitude to just greater than the peaks of the triangular ramp. When the dynamic brake is applied, this amplifier becomes a unity gain buffer for a DC level adjusted to insure the SA60 output is a low impedance, near zero voltage.

Even though the nominal motor inductance was adequate to keep ripple current in check, this inductance varied with position of the motor and a filter was used clean up the circuit.

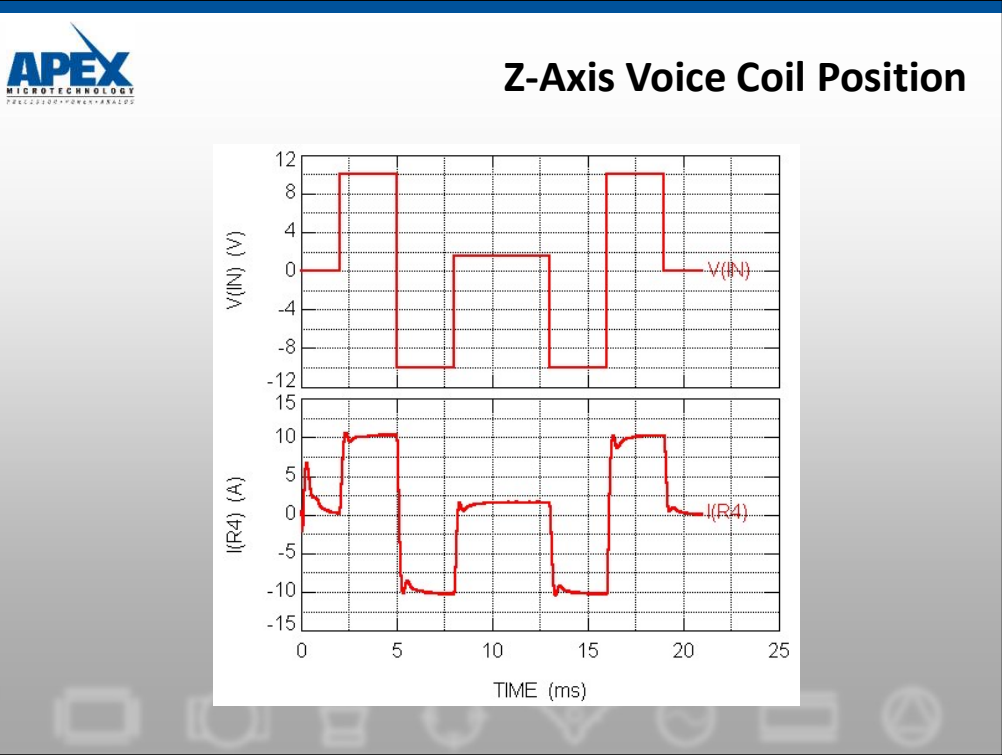

After power up settling, the first 3msec pulse accelerates the motor toward the work piece; the second 3msec pulse decelerates the motor; a constant pressure is held for 60msec (time was compressed in this plot); the last two pulses move the motor back to home position; and at t=150msec the cycle is repeated.

Here is a method to calculate a heatsink for this type application. First, assume a reasonable case temperature for the amplifier. We will pick 60°C. Application Note 11 tells us the temperature of a heatsink with any reasonable mass will change very little during the period of 150msec, so knowing average power dissipation over the cycle will establish a thermal rating.

Use Power Design to find the power levels for each of the three output current levels by entering a heatsink rating of .01 and adjusting ambient temperature to obtain a 60°case temperature. Enter a minimum frequency less than 60Hz to insure power is calculated for steady state. Here are the results:

I out	Ta	Power	Tj	msec	W*msec
.01	60	11.3	61	78	881
1.5	59	12.5	61	60	750
10	52	77.3	103	12	928

Total = 2559 Divide by 150 msec = 17.1W avg.

If ambient temperature is 25°C, a 2°C/W heatsink will allow a case temperature rise of about 34°, meeting the assumed 60°operating point.

While it was not shown in the schematic, it is imperative that a heatsink mounted over-temperature shutdown circuit be installed and set for less than 90°C. The over-temp limit was found in a similar manner as the previous



## Motor Ratings and Amplifier Selection

Can PA74A be used?

### MOTOR RATINGS:

Electro-Craft E 540A

Torque Constant: 10oz/in/A

Voltage Constant: 7.41V/KRPM

Winding Resistance: 1.24

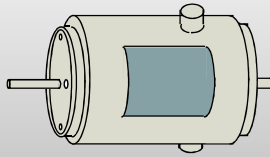

### APPLICATION REQUIREMENTS

10oz/in/torque

3240 RPM

24V @ 1A



Will the PA74 do? It is rated 2.5A peak. This application only needs 1A normally.

Ref. AN24

## Evaluation Against SOA

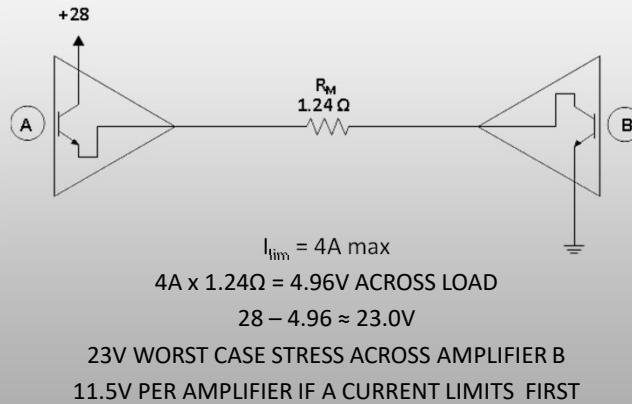

The above model provides us with a tool for analysis to examine worst case SOA stresses. This represents the condition for motor start-up or stall (not as demanding as instant motor reversal which is easily avoidable).

For this condition the motor is modeled as a 1.24 ohm resistance at stall. Assuming the PA74 current limit is at 4A results in a 4.96V drop across the load. Since it is not known which amplifier half will current limit first we must assume the worst case. If op amp B limits first all 23V of voltage stress will occur across it.

If op amp A were to current limit first or both op amp A and op amp B current limit at the same level then the voltage stresses would be equal at 11.5V across each.

For our SOA evaluation of the PA74 we will need to assume a 4A, 23V stress. In amplifiers with externally adjustable current limit we can guarantee op amp A current limits first by setting op amp B current limit 20% higher than that of op amp A and thereby equalizing voltage stresses across each op amp.

Ref. AN20,AN24



## PA74 Safe Operating Area (SOA)

1. Normal running condition
2. Start-up best case
3. Start-up worst case
4. Reversal worst case

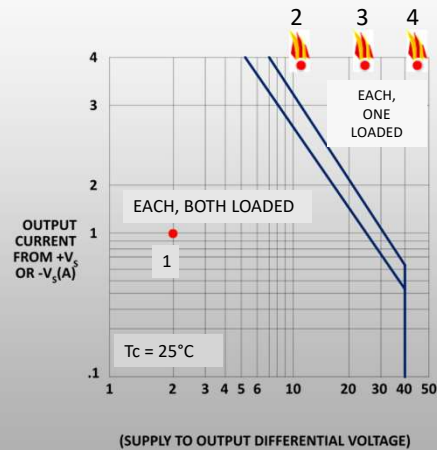

Plotted on the PA74 SOA graph are the four possible operating conditions for the PA74 when used with the Electro-Craft E540.

Point 1 is normal running condition which is well within the SOA boundaries.

Point 2 is the best case start-up condition where both op amp A and op amp B current limit at the same level or op amp A current limits first.

Point 3 is the worst case start-up condition where op amp B current limits first and bears the total voltage stress.

Point 4 is a worst case motor reversal condition with op amp B current limiting first.

It is readily apparent that with the PA74's non-adjustable internal current limit of 4A there is not sufficient SOA for driving this motor in start-up or stall conditions. Our alternatives will be either a complex soft-start circuit or power op amps with larger SOA.

Ref. AN20,AN24



## Protection Alternatives

### PA61 – Improved SOA + Current Limit Adjustment

START-UP		
I <sub>um</sub>	V <sub>S</sub> -V <sub>O</sub>	
10A	8V	(1)
7A	10V	(2)
4A	12V	(3)

REVERSAL		
I <sub>um</sub>	V <sub>S</sub> -V <sub>O</sub>	
5A	25V	(1)
2.5A	26V	(2)
2A	27V	(3)

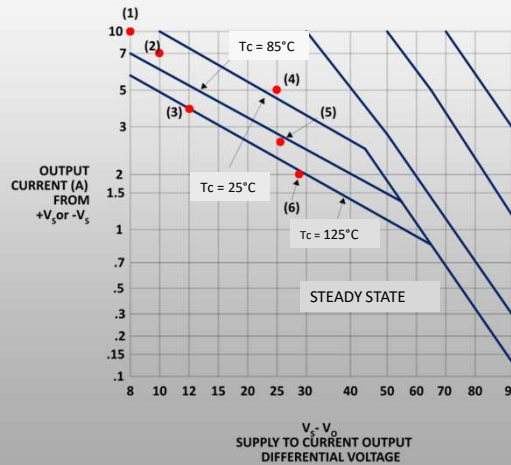

Often the only solution to the conflicting requirement of protection along with reasonable motor acceleration is simply an amplifier with a larger SOA. Not only does the PA61 provide a better SOA fit but the programmable current limit provides additional flexibility in meeting SOA requirements.

Points 1 thru 6 above on the PA61 SOA plot show a variety of operating choices depending upon what start-up current is desired, whether motor reversals are a possibility, and what heatsinking is available referenced to op amp case temperature. The following handy formulae provide a quick way for estimating these points given a properly designed bridge circuit.

$$\text{START-UP: } V_s - V_o(\text{each op amp}) = V_s - (I_{\text{limit}} * \text{Motor resistance})/2$$

$$\text{REVERSAL: } V_s - V_o(\text{each op amp}) = 2 * V_s - (I_{\text{limit}} * \text{Motor resistance})/2$$

Where: V<sub>s</sub> = total supply voltage.

If using a single amplifier rather than a bridge, delete the “/2” term. The reversal formula makes 2 assumptions: Prior to reversal, output voltage was saturated all the way to the rail and motor back EMF = V<sub>s</sub>. This may not be true by virtue of input signal level, and cannot be true by virtue of the output voltage swing spec of the amplifier (saturation limit) and plus it requires a zero ohm motor. Despite all this it’s a good first order approximation.



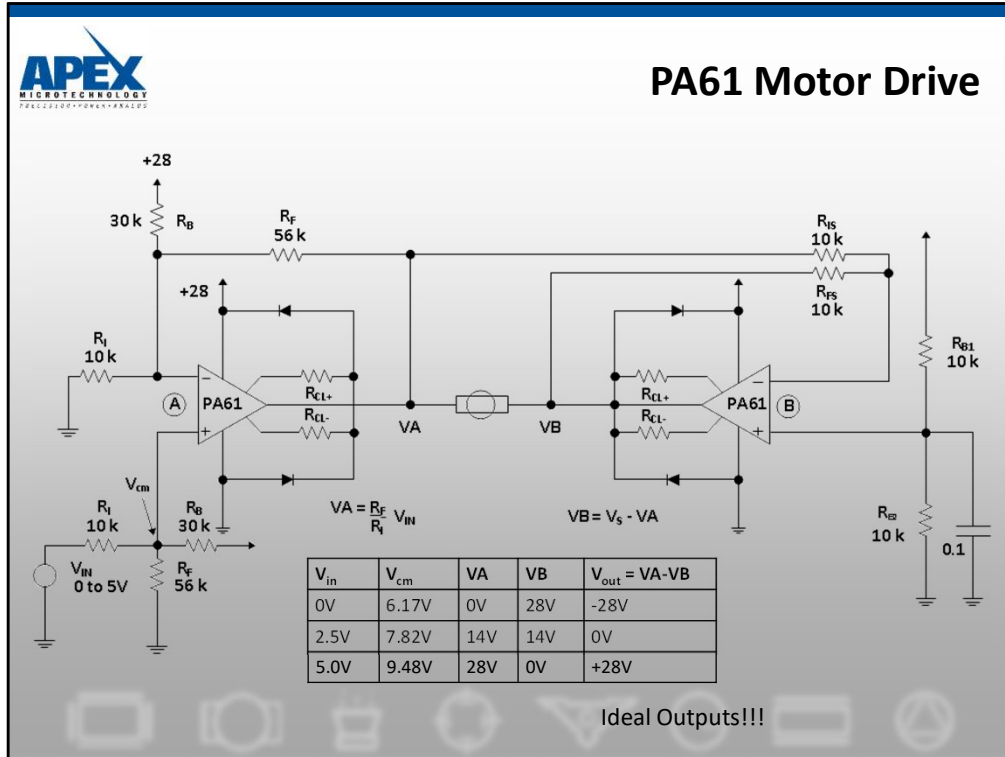

Our first alternate drive circuit for controlling the Electro-Craft motor utilizes a bridge of PA61 class “C” power op amps. Class “C” amplifiers are usually less expensive than similar class “AB” devices. While our PA61 implementation does require more components, than would our original PA21 circuit, it has the SOA to withstand start-up and even reversal conditions. Note that the PA61 has enough voltage range to handle this motor with a single amplifier. If the 28V supply is already part of the system, this may not be a good economic choice. PA73 is a 5A class “C” amplifier which would be a good candidate if high speed mechanical response is not of prime concern.

Amplifier A uses our Single Supply Non-Inverting Configuration seen previously to meet the common mode scaling requirements of the PA61. Gain scaling with this arrangement is set to try to drive the amplifier into saturation trying to achieve 0V or +28V out of the amplifier. This scaling needs to be cut back according to the saturation voltage of the specific amplifier at the specific output current level to be used. The specification is labeled Voltage Swing in the data sheet. This voltage is lost twice in a bridge circuit, once for each amplifier.

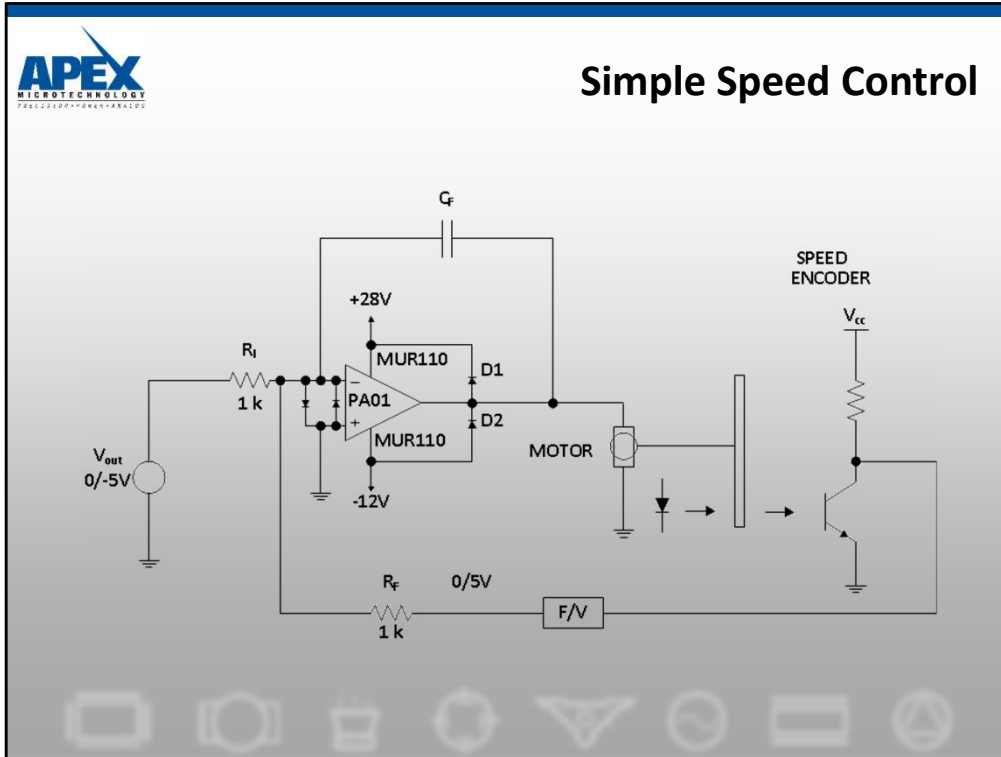

In speed control circuits the usual approach taken is to integrate the difference between an input voltage signal and a feedback signal that gives information about the speed of the motor being driven. In the application above a PA01 is being used to drive a DC motor with an integral speed encoder that outputs a pulse train whose frequency is proportional to the angular velocity of the motor. This signal is then fed to a VFC, or Voltage to Frequency Converter, that is operated in the frequency to voltage mode. The output voltage of the VFC appears across  $R_f$  to create a current into the summing node of the amplifier. Likewise,  $V_{ctl}$  appears across  $R_i$  to create a current out of the summing node. When:  $V_o(VFC) = -V_{ctl}$ , then no current is fed to  $C_f$ , the integrating capacitor. If there is a difference between the current fed into the summing node by the Vfc and the current removed out of the node by the control voltage the difference current is fed to the integrating capacitor resulting in a change in output voltage which acts to correct the error.

Note that since the PA01 is driving a DC motor which can generate a continuous train of high frequency kickback pulses external flyback protection diodes, MUR110's were added from the output to the supplies in order to protect the PA01's output stage.

Unless dynamic braking is used, the -12V supply needs to support amplifier quiescent current only; a maximum of 50mA for the PA01.

## Current-to-Current Converter

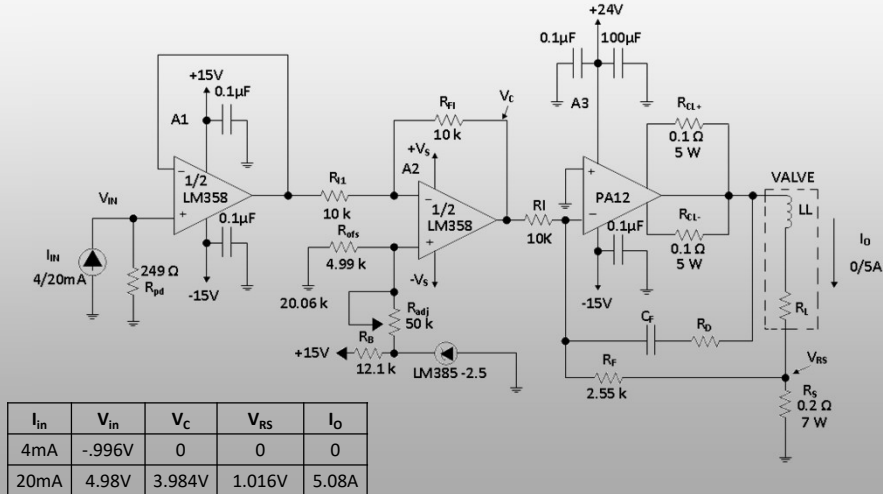

This circuit provides a Current-to-Current converter function through translation of a 4-20mA current transmitter to 0-5A output for linear control of a valve.

The 4-20mA is converted to a voltage through the use of a 249 ohm pull down resistor and buffered by A1. This voltage,  $V_{IN}$ , is then offset to zero through the use of a precision voltage reference and a summing amplifier. Voltage  $V_C$  then becomes the input command for the Voltage-to-Current conversion output stage using the PA12.

To guarantee AC small signal stability, stability analysis needs to be done using the load resistance and inductance of the actual linear valve to be used. These stability techniques we have covered previously. Be aware that valve inductance is likely a dynamic parameter changing with position of the valve.

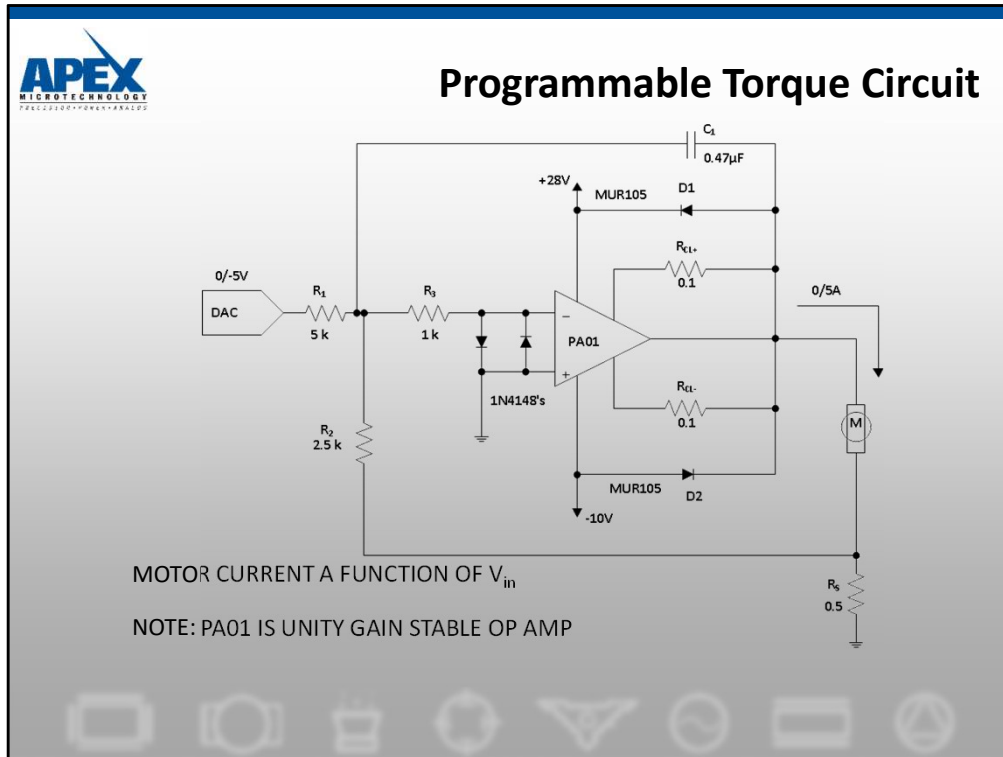

This schematic uses several tricks that we've learned. First of all, notice that the PA01 is operating from non-symmetrical supplies. The  $-10$  volt supply is merely to provide input common mode bias. The  $28$  volt supply is used to supply the load current.

In a motor, torque is directly proportional to current, so this is another form of voltage to current conversion. The inverting node of the PA01 is used as a summing node. Into the summing node flow two currents, one is the input voltage from the DAC across  $R_1$ , the second is the feedback voltage ( $I_{load} * R_s$ ) across  $R_2$ . These two currents are summed and the difference current is fed to  $C_1$  to be integrated. When the current through the motor is at the proper value the voltage across  $R_s$  will produce a current into the summing node that is equal to the current out of the summing node from the DAC. This results in no current flow to the integrating capacitor  $C_1$  resulting in a fixed output current.

Note that since the PA01 is driving a motor, high speed flyback diodes, MUR105s, are used to protect the amplifier's output stage against flyback voltage spikes. Also note that in integration type circuits the integration capacitor is connected directly from the output of the amplifier to the input. This means that high frequency pulses can be fed back directly to the input stage. Therefore we show 1N4148 input protection diodes and  $R_3$  in this application to prevent input stage damage to the PA01 caused by flyback coupling through  $C_1$

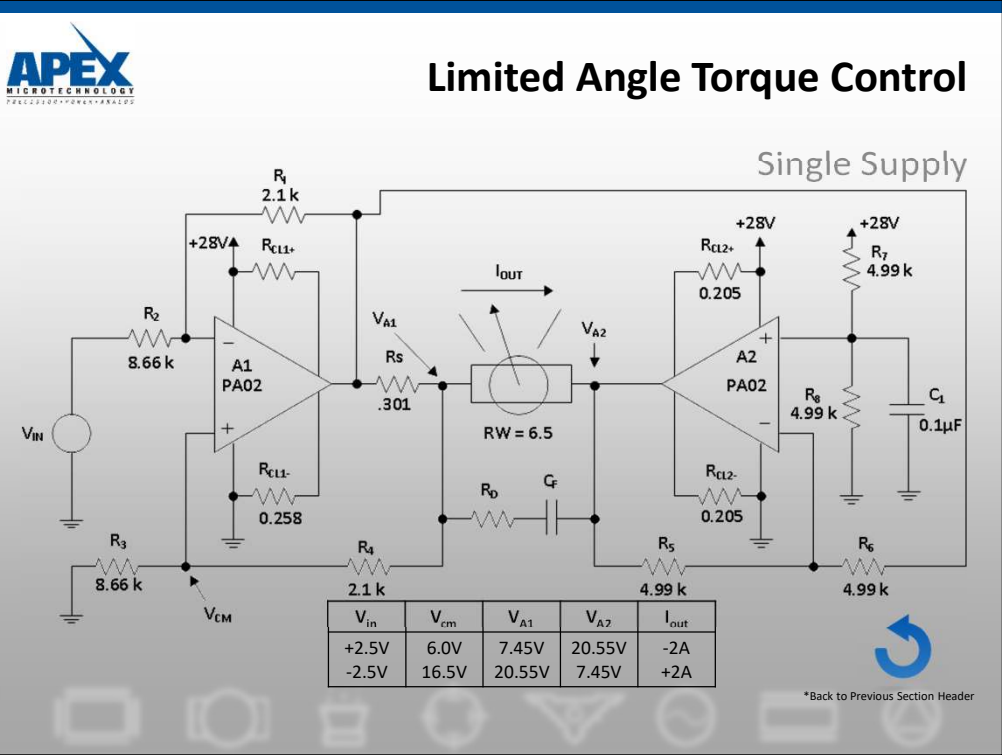

This real world application shows implementation of the generic case of V to I single supply. It combines bridge mode operation with the improved Howland current pump. The limited angle torquer will see bipolar current changes for bipolar input voltages.

Note that the  $V_s - 6$  common mode voltage range is met under both conditions of output voltage swing on A1. Also note that the peak output voltage swing is limited to less than  $V_s - (2 * V_{cm})$  as was mentioned in the generic case for this configuration.

Although we are driving an inductive load we need no external flyback diodes since the PA02 has internal fast reverse recovery diodes. A full plus and minus 2 Amps is available for position control of the limited angle torquer despite the availability of only a single supply.

Ref. AN21